

Technical Specification

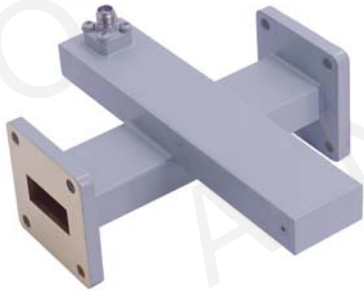

EIA WR	WR90
Frequency Range(GHz)	8.2-12.4
Coupling(dB)	30
Coupling Accuracy(dB)	±0.7 Max.
Frequency Sensitivity(dB)	±1.0 Max.
Directivity(dB)	18 Min.
Insertion Loss(dB)	0.1 Max. (Not including the theoretical loss 4.35×10^{-3} dB)
Mainline VSWR	1.10:1 Max.
Secondline VSWR	1.25:1 Max.
Flange	FBP100(UBR100)
Coupling Port	SMA-Female/SMA-Male
Material	Cu
Size(mm)	120.7 x 101.6 x 51.1
Net Weight(Kg)	0.35 Around

Outline Drawing (Size: mm)

Coupling Port: SMA -Female

For SMA-Male connector Coupling Port outline drawing, please contact A-INFO.

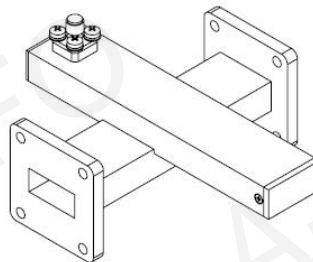
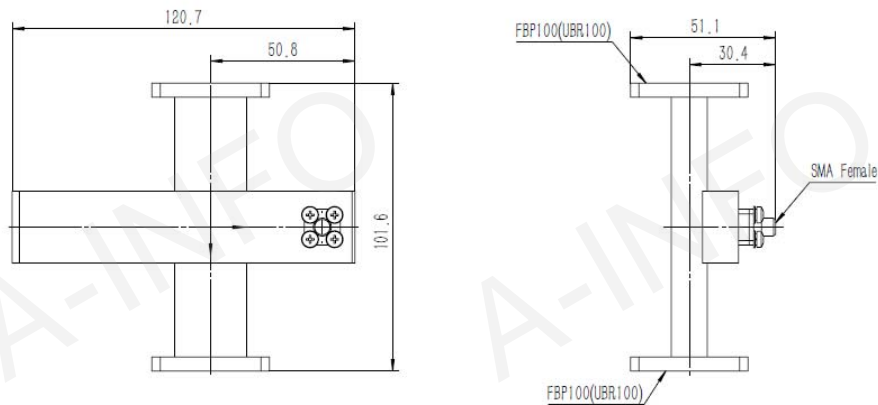

Flange Drawing (Size: mm)

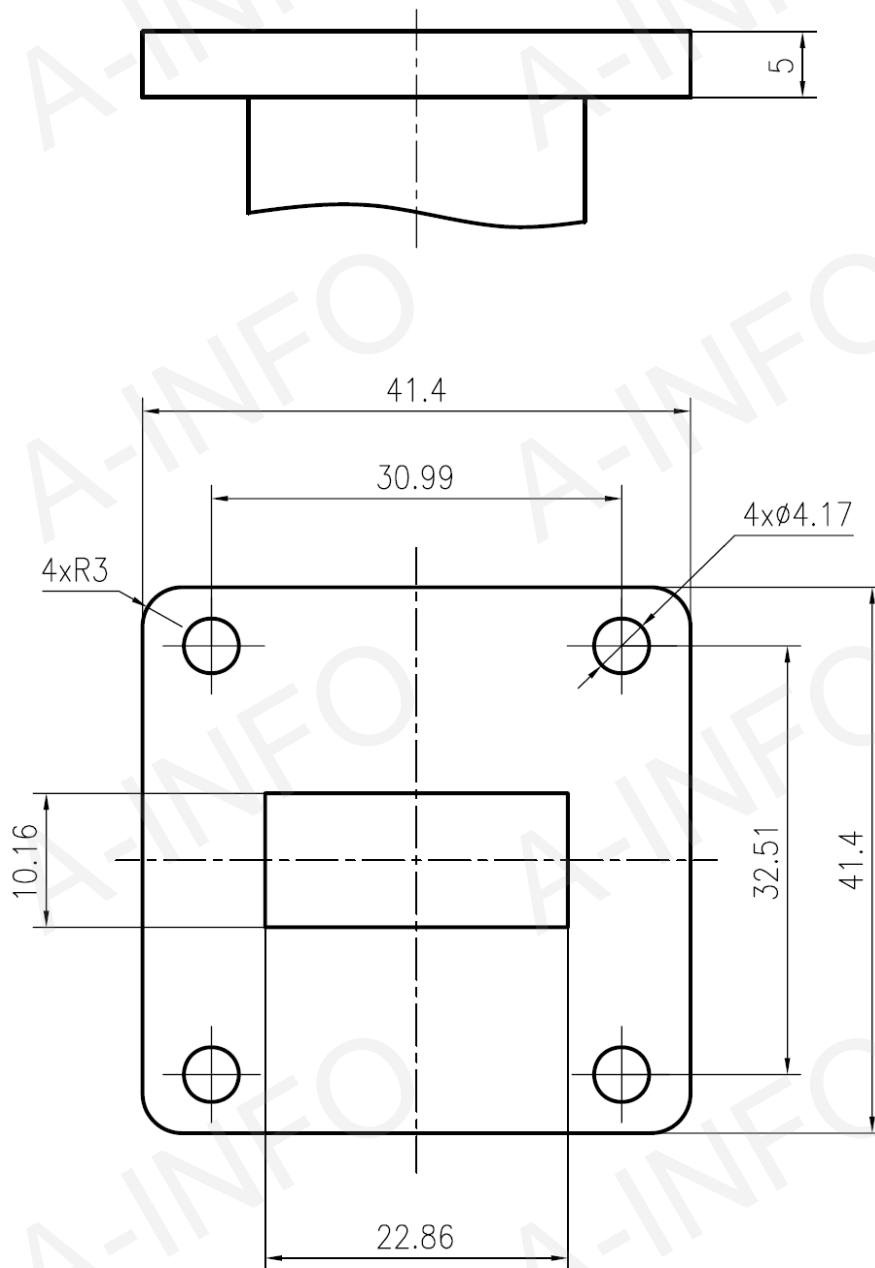

FBP100

AINFO Inc.

China(Beijing):
China(Chengdu):
USA :

Tel: (+86) 10-6266-7326,
Tel: (+86) 28-8519-2786,
Tel: (+1) 949-639-9688,

(+86) 10-6266-7327
(+86) 28-8519-3044
(+1) 949-639-9608

Page 2 of 5
Fax: (+86) 10-6266-7379
Fax: (+86) 28-8519-3068
Fax: (+1) 949-639-9670

Website: www.ainfoinc.com
Email: sales@ainfoinc.com

Test Results

Coupling

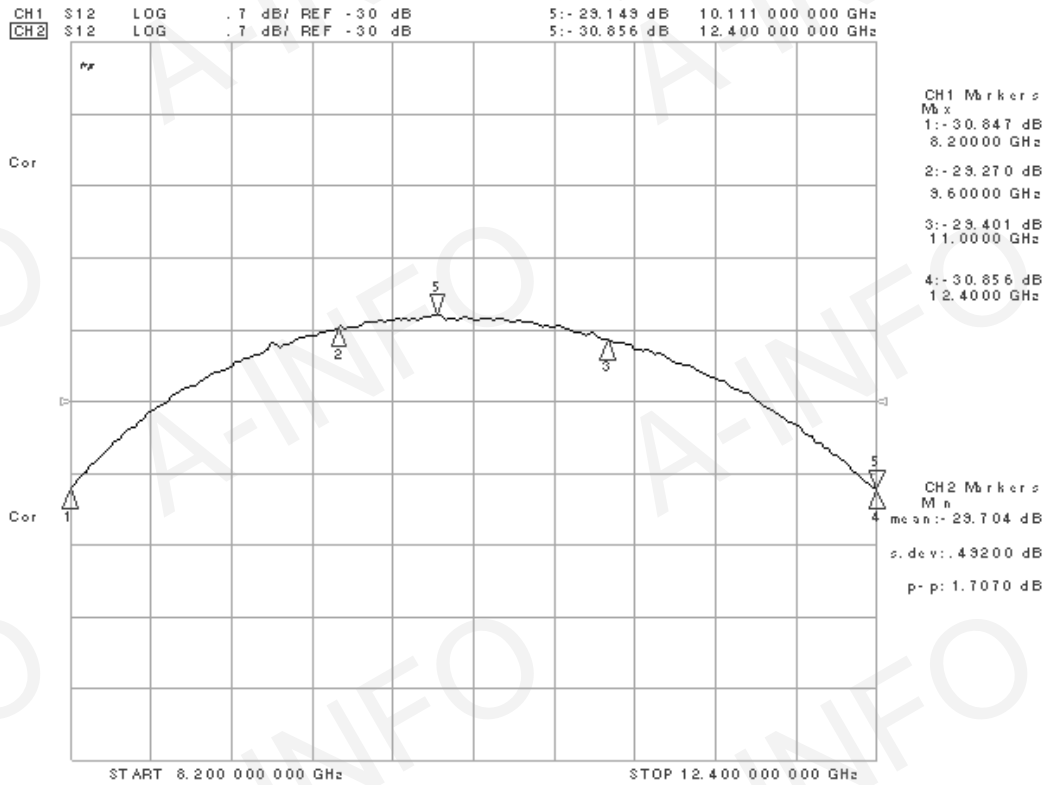

Directivity

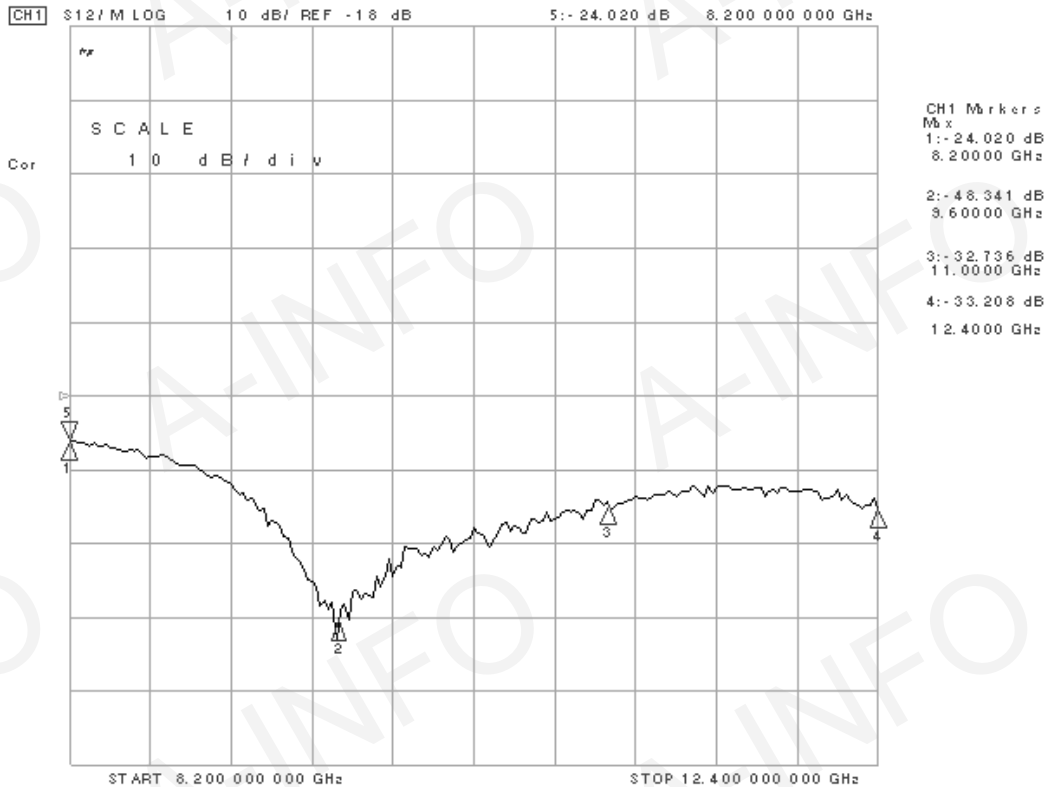

I.L. (Including the theoretical loss 4.35×10^{-3} dB)

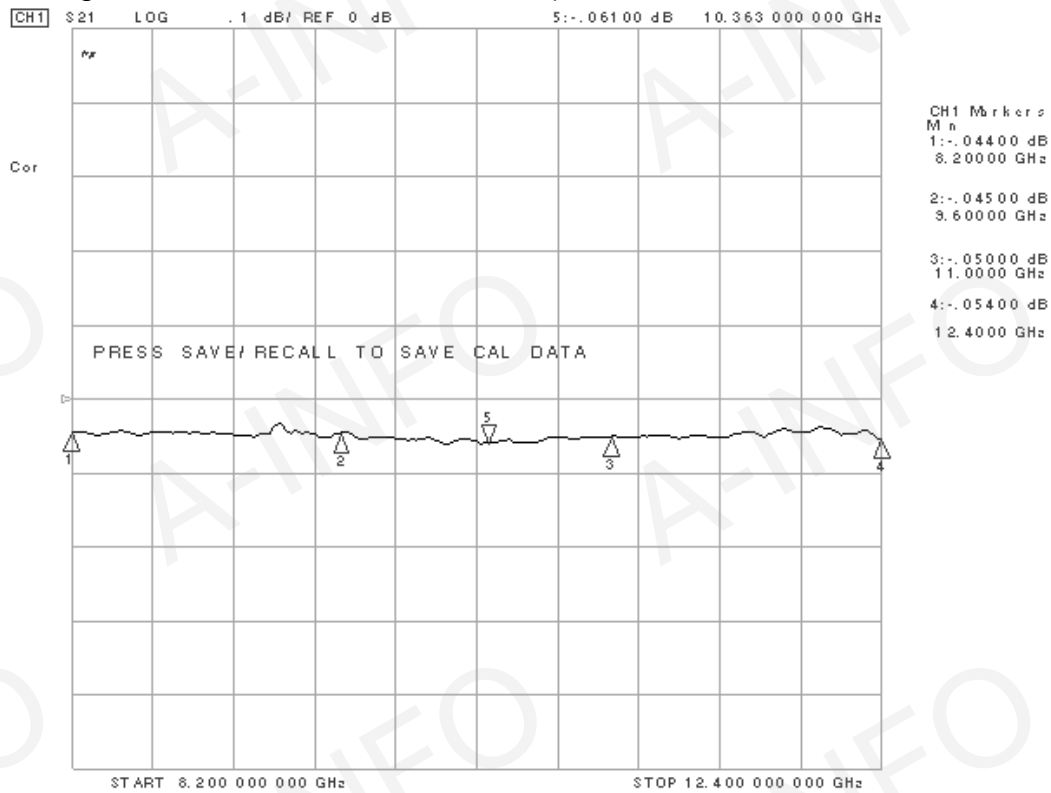

Mainline VSWR

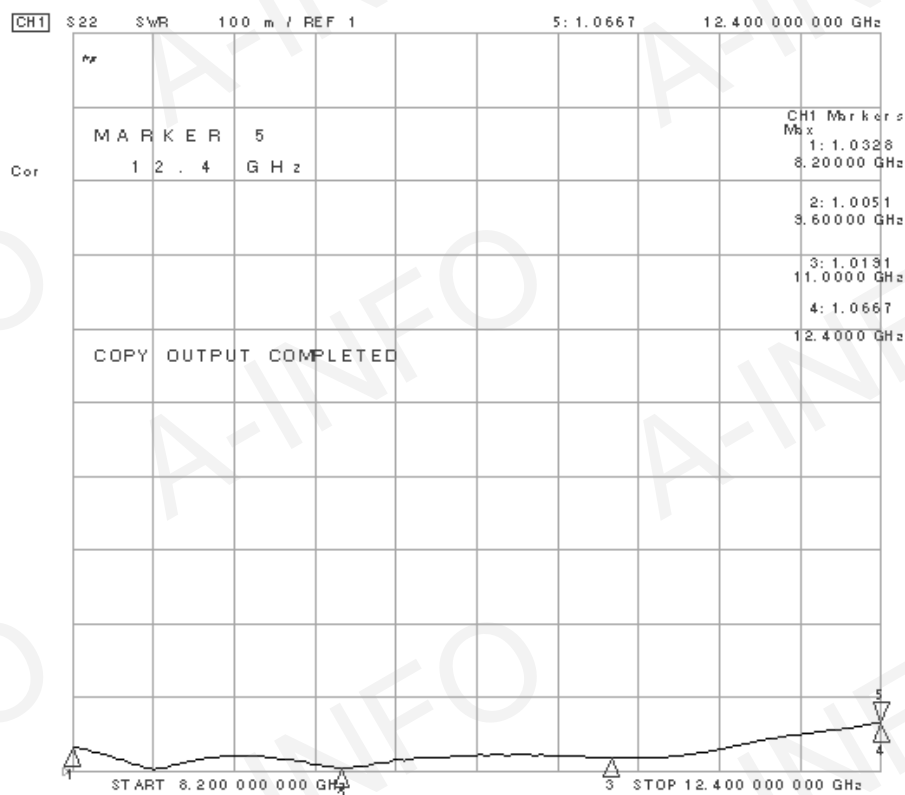

AINFO Inc.

China(Beijing):
China(Chengdu):
USA:

Tel: (+86) 10-6266-7326,
Tel: (+86) 28-8519-2786,
Tel: (+1) 949-639-9688,

(+86) 10-6266-7327
(+86) 28-8519-3044
(+1) 949-639-9608

Fax: (+86) 10-6266-7379
Fax: (+86) 28-8519-3068
Fax: (+1) 949-639-9670

Page 4 of 5

Website: www.ainfoinc.com
Email: sales@ainfoinc.com

Secondline VSWR

